

























N9

Datenblatt



Abbildung: N9 | Naturstein (zweifarbzig): Caliza Moka mit Negro Abanilla

Standard	Gesamtgewicht	Optional	Zubehör	Naturstein	Kamineinsatz
 Front Kristall	 ca. 420 kg	 Tür hochschiebbar	 Heizwasser-Aufsatzregister R	 Aufsatzspeicher	 Lina 5557 s NW-Leistung: 7 kW Abgasstutzen: Ø 180 mm  Energieeffizienzklasse nach (EU) 2015/1186 für Kamineinsatz Mehr Infos unter www.camina-schmid.de
 Tür schwenkbar Anschlag li./re.		 Doppelverglasung	 Warmluft-Aufsatzregister	 Außenbefuerung	
		 Tunnelversion	 SMR	 Vorlegeplatte	
				 Blanco Carrara	
				 Blanco Macael	
				 Blanco Nacarado	
				 Caliza Moka	
				 Crema Marfil	
				 Marron Emperador	
				 Travertino Romano	
				 Negro Abanilla	
				 Rojo Alicante	
				 Rosa Claro	
				 Rosa Crema	
				Weitere Natursteinausführungen auf Anfrage erhältlich.	

N9

Maßzeichnung

Frontansicht M 1:25

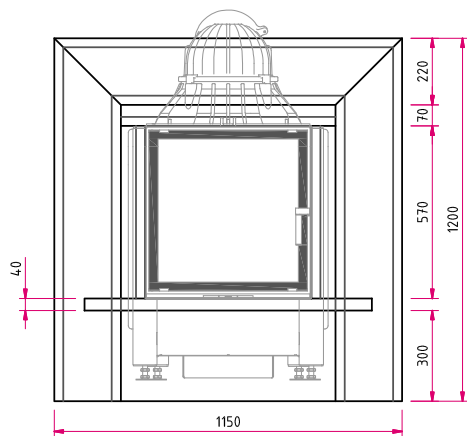

Seitenansicht M 1:25

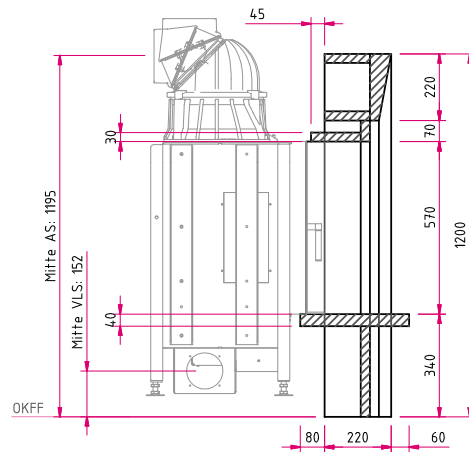

Draufsicht M 1:25

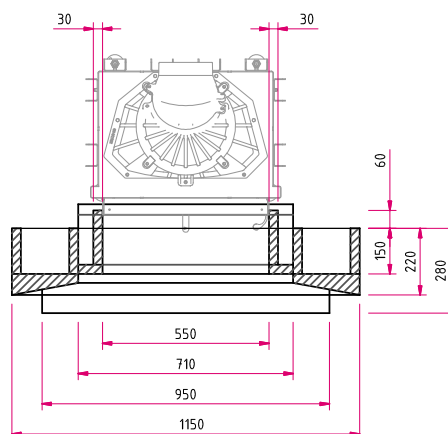

Hinweis Seitenansicht M 1:25: AS: Abgasstutzen, VLS: Verbrennungsluftstutzen, OKFF: Oberkante Fertigfußboden

Bitte beachten Sie die Angaben für **optionales Zubehör** in unserer Preisliste.

Abbildungen ähnlich. Alle Abbildungen und Zeichnungen sind urheberrechtlich geschützt. Verwertung oder Veröffentlichung, auch einzelner Details, nur mit unserer Genehmigung. Farbliche und technische Änderungen durch Weiterentwicklungen sowie Irrtümer vorbehalten. Stand: 07/2018