























# N32 Oxford

## Datenblatt



Abbildung: N32 (Oxford) | Naturstein: Caliza Moka

Standard	Gesamtgewicht	Optional	Zubehör	Naturstein	Kamineinsatz
 <p>Front Kristall</p>  <p>Tür hochschiebbar</p>	 <p>ca. 460 kg</p>	 <p>Front Kristall + (außer Lina W)</p>  <p>Doppelverglasung</p>  <p>Tunnelversion</p>	 <p>Heizwasser-Aufsatzregister R</p>  <p>Kesselgerät Lina W</p>  <p>Aufsatzspeicher</p>  <p>Elektronischer Türantrieb</p>  <p>SMR</p>  <p>Wärmeluft-Aufsatzregister</p>  <p>Außenbefuerung</p>  <p>Vorlegeplatte</p>	 <p><i>Blanco Carrara</i></p>  <p><i>Blanco Macael</i></p>  <p><i>Blanco Nacarado</i></p>  <p><i>Caliza Moka</i></p>  <p><i>Crema Marfil</i></p>  <p><i>Marron Emperador</i></p>  <p><i>Travertino Romano</i></p>  <p><i>Negro Abanilla</i></p>  <p><i>Rojo Alicante</i></p>  <p><i>Rosa Claro</i></p>  <p><i>Rosa Crema</i></p> <p>Weitere Natursteinausführungen auf Anfrage erhältlich.</p>	 <p>Lina 7363 h NW-Leistung: 9 kW Abgasstutzen: Ø 200 mm</p>  <p>Energieeffizienzklasse nach (EU) 2015/1186 für Kamineinsatz</p> <p>Mehr Infos unter <a href="http://www.camina-schmid.de">www.camina-schmid.de</a></p>

# N32 Oxford Maßzeichnung

Frontansicht M 1:25

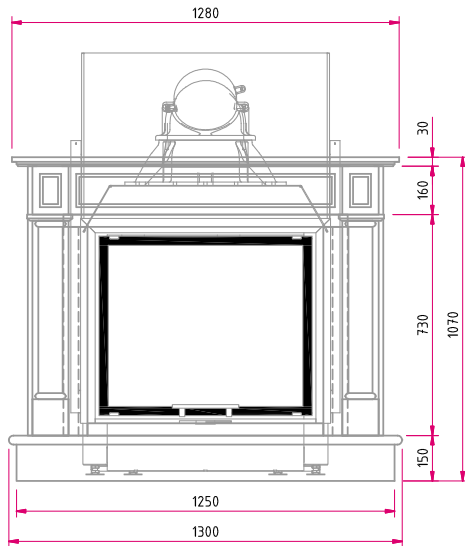

Seitenansicht M 1:25

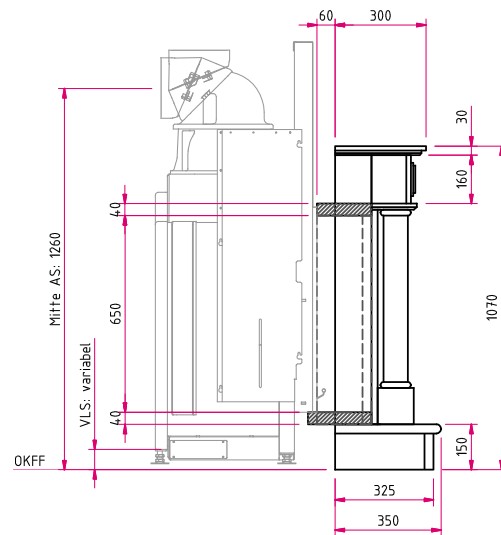

Draufsicht M 1:25

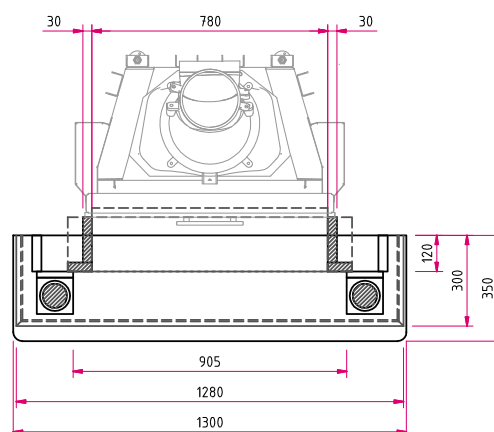

**Hinweis Seitenansicht M 1:25:** AS: Abgasstutzen, VLS: Verbrennungsluftstutzen, OKFF: Oberkante Fertigfußboden

Bitte beachten Sie die Angaben für **optionales Zubehör** in unserer Preisliste.

Abbildungen ähnlich. Alle Abbildungen und Zeichnungen sind urheberrechtlich geschützt. Verwertung oder Veröffentlichung, auch einzelner Details, nur mit unserer Genehmigung. Farbliche und technische Änderungen durch Weiterentwicklungen sowie Irrtümer vorbehalten. Stand: 07/2018