



























N1

Datenblatt



Abbildung: N1 | Naturstein (zweifarbzig): Blanco Nacarado mit Negro Abanilla

Standard	Gesamtgewicht	Optional	Zubehör	Naturstein	Kamineinsatz
 Front Kristall	 ca. 470 kg	 Front Kristall + (außer Lina W)	 Heizwasser-Aufsatzregister R	 Kesselgerät Lina W	 Lina 7363 h NW-Leistung: 9 kW Abgasstutzen: Ø 200 mm  Energieeffizienzklasse nach (EU) 2015/1186 für Kamineinsatz Mehr Infos unter www.camina-schmid.de
 Tür hochschiebbar		 Doppelverglasung	 Aufsatzspeicher	 Warmluft-Aufsatzregister	
		 Tunnelversion	 Elektronischer Türantrieb	 Außenbefuerung	
			 SMR	 Travertino Romano	
			 Vorlegeplatte	 Negro Abanilla	
				 Blanco Carrara	
				 Blanco Macael	
				 Blanco Nacarado	
				 Caliza Moka	
				 Crema Marfil	
				 Marron Emperador	
				 Rosa Clara	
				 Rojo Alicante	
				 Rosa Crema	
				Weitere Natursteinausführungen auf Anfrage erhältlich.	

N1

Maßzeichnung

Frontansicht M 1:25

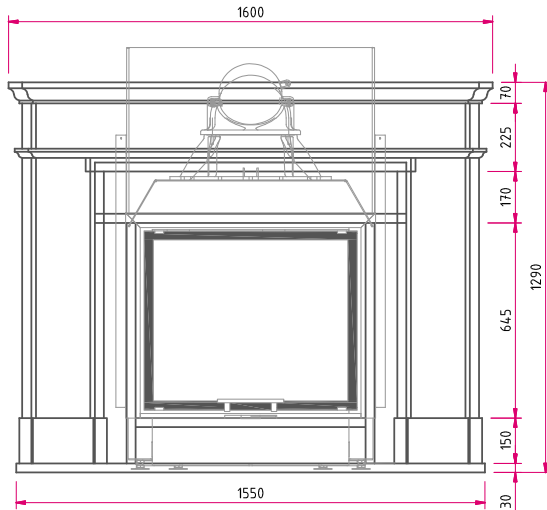

Seitenansicht M 1:25

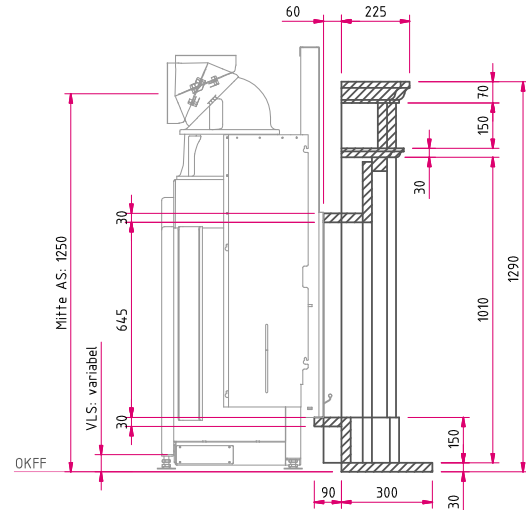

Draufsicht M 1:25

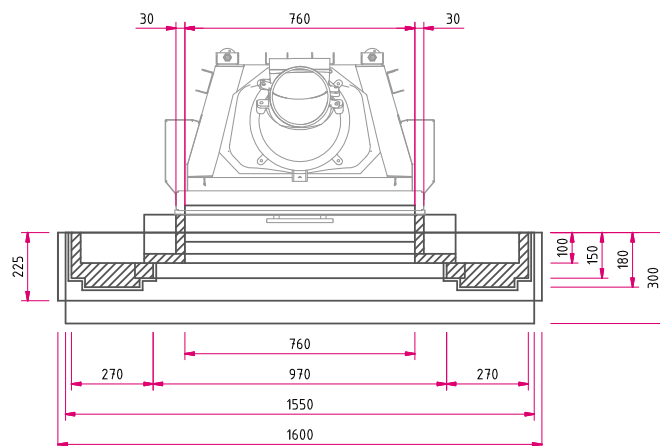

Hinweis Seitenansicht M 1:25: AS: Abgasstutzen, VLS: Verbrennungsluftstutzen, OKFF: Oberkante Fertigfußboden

Bitte beachten Sie die Angaben für **optionales Zubehör** in unserer Preisliste.

Abbildungen ähnlich. Alle Abbildungen und Zeichnungen sind urheberrechtlich geschützt. Verwertung oder Veröffentlichung, auch einzelner Details, nur mit unserer Genehmigung. Farbliche und technische Änderungen durch Weiterentwicklungen sowie Irrtümer vorbehalten. Stand: 07/2018