

S9 Hoch

Speicherstein



Abbildung: S9 Hoch
Oberflächenveredelung:
Camina Sichtbetonoptik



Abbildung: S9 Hoch in Kombination
mit Naturstein-Bank Nero matt (ohne
Überstand)
Oberflächenveredelung:
Camina Sichtbetonoptik

Abbildung: S9 Hoch in Kombination mit Designbeton
Oberflächenveredelung: Camina Silikatanstrich

Standard



Tür schwenkbar
Anschlag li./re.



Front Kristall

Gesamtgewicht



ca.
630 kg

Kamineinsatz

Ekko 45(45)57 s
NW-Leistung: 7 kW
Abgasstutzen: Ø 180 mm



A

Mehr Infos unter
www.camina-schmid.de

Optional



Tür
hochschiebbar

Zubehör



Heizwasser-
Aufsatzregister R



Aufsatz-
speicher



SMR



Vorlegeplatte

Naturstein und Speicherbeton

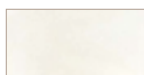

Estremos



Grigio



Jade



Marone



Mocca Creme



Nero



Nero matt



Sabbia



Speicherbeton



Designbeton

Frontansicht M 1:20

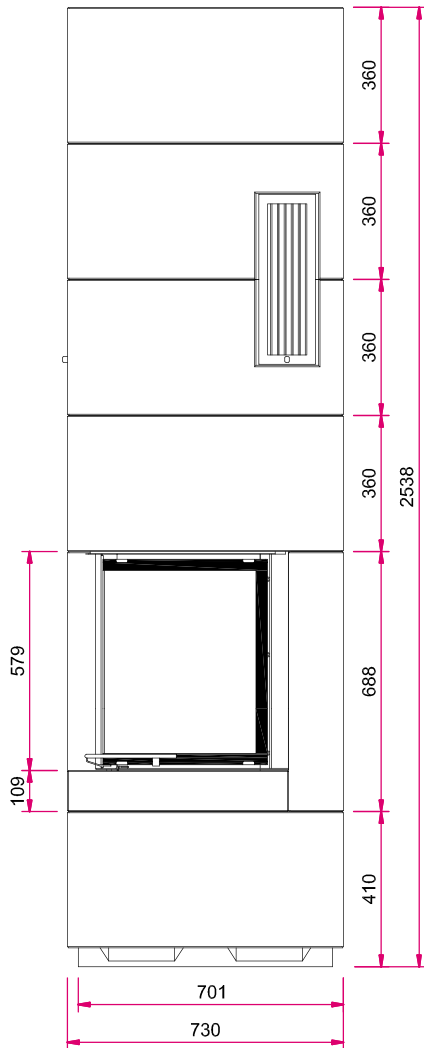

Seitenansicht links M 1:20

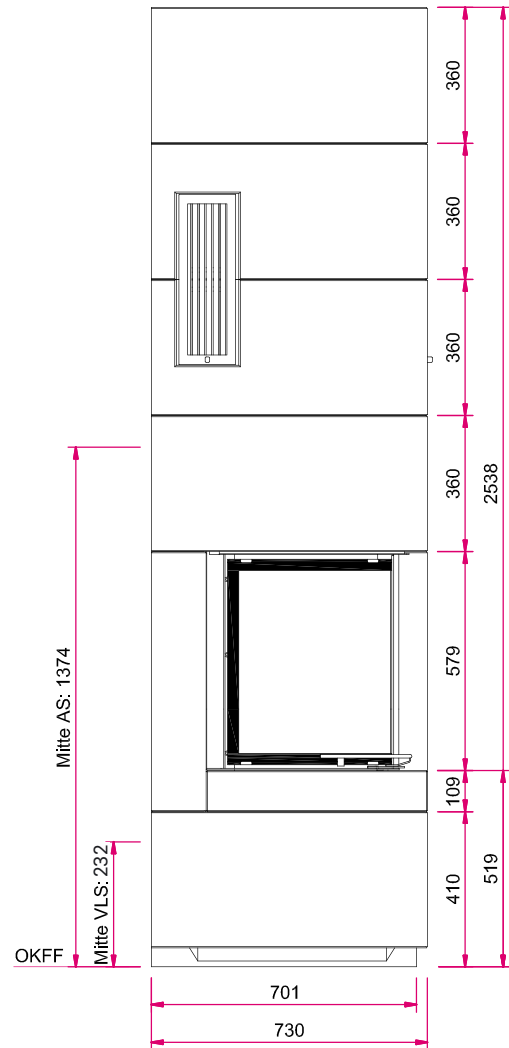

Hinweis: Mit optionalem Zubehör bitte die Angaben in den Preislisten beachten.
AS: Abgasutzen, VLS: Verbrennungsluftutzen, OKFF: Oberkante Fertigfußboden

Draufsicht M 1:20

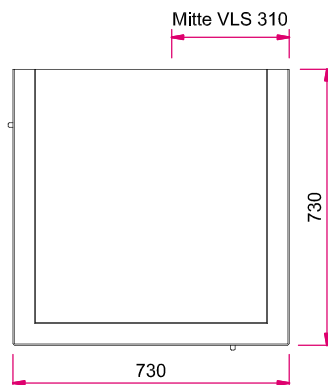

S9 Hoch mit Naturstein-Bank (mit Überstand) Speicherstein



Abbildung: S9 Hoch
Oberflächenveredelung:
Camina Sichtbetonoptik

Abbildung: S9 Hoch in Kombination mit Naturstein-Bank Grigio (mit Überstand)
Oberflächenveredelung: Camina Sichtbetonoptik

Standard



Tür schwenkbar
Anschlag li./re.



Front Kristall

Gesamtgewicht



ca.
630 kg

Kamineinsatz

Ekko 45(45)57 s
NW-Leistung: 7 kW
Abgasstutzen: Ø 180 mm

Optional



Tür
hochschiebbar



Mehr Infos unter
www.camina-schmid.de

Zubehör



Heizwasser-
Aufsatzregister R



Aufsatz-
speicher



SMR



Vorlegeplatte

Naturstein und Speicherbeton

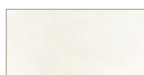

Estremos



Grigio



Jade



Marone



Mocca Creme



Nero



Nero matt



Sabbia



Speicherbeton



Designbeton

Maßzeichnungen S9 Hoch mit Naturstein-Bank (mit Überstand)

Frontansicht M 1:20

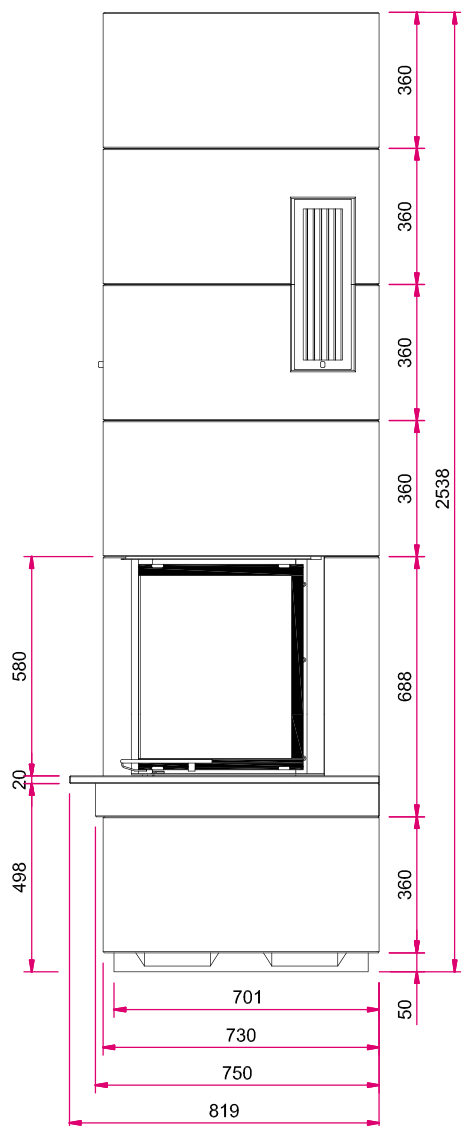

Seitenansicht links M 1:20

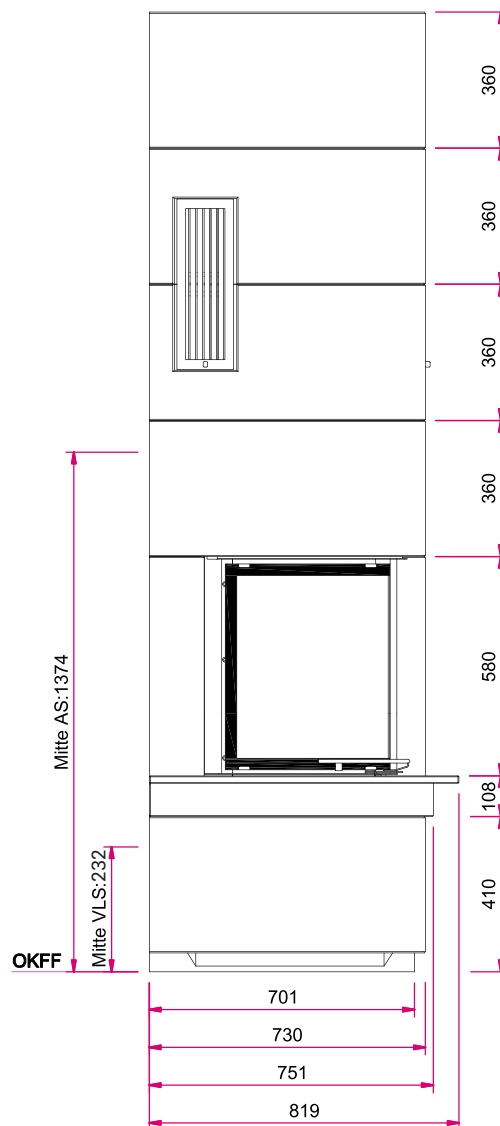

Hinweis: Mit optionalem Zubehör bitte die Angaben in den Preislisten beachten.
AS: Abgasutzen, VLS: Verbrennungsluftutzen, OKFF: Oberkante Fertigfußboden

Draufsicht M 1:20

